

Insulated flue system <SKS-X-IZ>

Insulated flue system is made of acid-resistant chrome-nickel stainless sheet. Inner pipe application (type 1.4301 acc. to DIN 17441 of thicknesses of 0.4 and 0.6 mm) is fume wet extraction from modern, energy-saving gas, oil boilers and pellet stoves. Outer pipe type is 1.4301 of thicknesses of 0.4 and 0.5 mm. Thermal insulation is made from mineral wool of thickness 30 mm.

Chimney system made of SKS-X-IZ elements is an independent construction. (there is no need to use ceramic materials).

Maximum working temperature: 250°C



Application of chimneys and recommended sheet thicknesses

Diameter DN	S, D* 1.4301	** 1.4301
60	0.4	-
80	0.4	-
100	0.4	-
120	0.4	0.4
130	0.4	-
140	0.4	0.4
150	0.5	-
160	0.5	0.5
180	0.5	0.5
190	0.5	0.5
200	0.5	-
210	0.5	0.5
220	-	0.5
240	-	0.5
250	0.6	-
260	-	0.5
310	-	0.5

Table of layouts and sizes

Diameter DN	Lr	Dz	Dw	Dk	s
60	188	60.2	59.4	60.5	0.4
80	250	80.0	79.2	81.0	
100	315	100.7	99.9	101.7	
120	385	122.9	122.1	123.9	
130	415	132.5	131.7	133.5	
140	440	140.5	139.7	141.5	
150	475	151.7	150.7	152.7	0.5
160	505	161.2	160.2	162.2	
180	570	181.9	180.9	182.9	
190	595	189.9	188.9	190.9	
200	630	201.0	200.0	202.0	
210	660	210.6	209.6	211.6	
220	690	220.2	219.0	221.0	0.6
240	753	240.3	239.1	241.3	
250	790	252.1	250.9	253.1	
260	818	261.2	259.6	262.2	
310	974	310.6	309.4	311.6	

Destination

S - flue ducts (gas, oil)

D* - outer pipe

** -

Measurements

Lr - metal sheet layout [mm]±0.1

Dz - outer diameter of pipe [mm] ±0.1

Dw - inner diameter of pipe [mm] ±0.1

Dk - inner diameter of bell [mm] ±0.1

s - metal sheet thickness [mm]

Bell joint pipe connection

Individual elements of the chimney system are being joint by the way of pushing one part of the element - a spigot, into the other press-formed part of the element - a bell. Thanks to this type of pipe joining, metal chimney is characterized by very tight and stiff construction. It also assures proper flow of condensate, along walls of the chimney straight to condensate drain bowl. Outer elements are connected "bell down" what prevents chimney insulation from rain water. Outer casings of the chimney elements should be riveted together with couple of stainless steel rivets before placing a fastening clamp. Usage of a special seal made of silicone, which is applied in the middle of the bell, secures tightness of the system by positive pressure of fumes up to 200Pa.

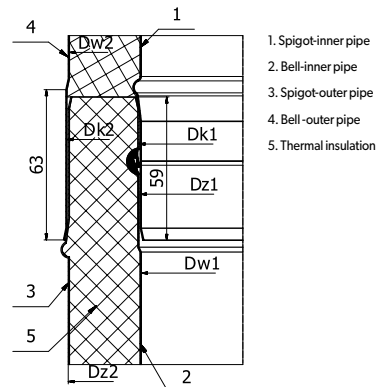
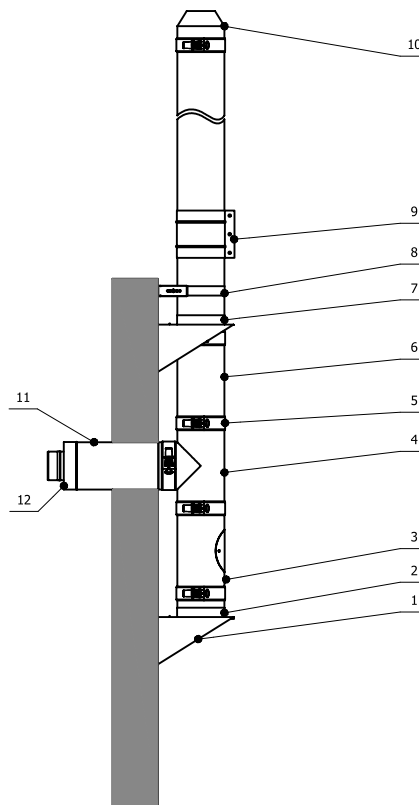
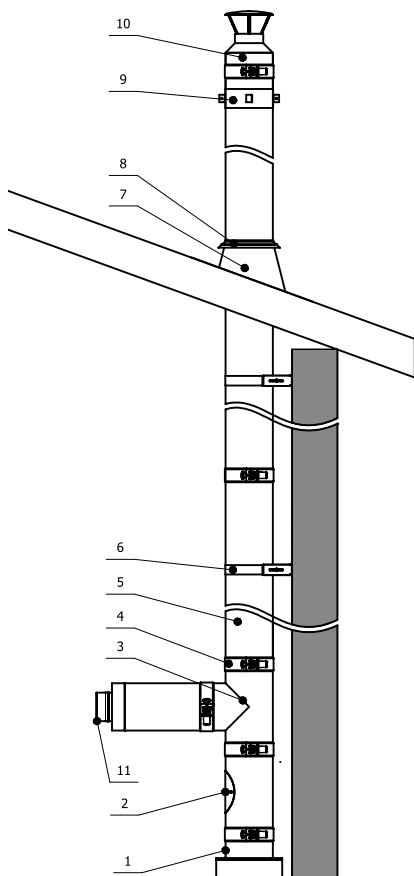

Fig. Method of joining double-walled pipe elements.

Model application of elements



No	Name	Denotation
1	Bowl	MSD100/160-KS-X4-IZ
2	Straight pipe with revision	RPDr100/160-KS-X4-IZ
3	Tee	TRD100/160/90-KS-X4-IZ
4	Clamp	OPIV160-X
5	Straight pipe	RPD100/160/1000-KS-X4-IZ
6	Mounting bracket	OMD-II-160-X/50-150
7	Angular roof flashing	PKI160/20-X
8	Rain collar	KPD160-X
9	Bracket for stabilizing cords	OPO160-X
10	Cap	DKD100/160-KS-X4-IZ
11	Tee plug	ZTD100/160-KS-X4-IZ

No	Name	Denotation
1	Supporting console	KWD160-X/50-150
2	Bowl	MSD100/160-KS-X4-IZ
3	Straight pipe with revision	RPDr100/160/250-KS-X4-IZ
4	Tee	TRD100/160/90-KS-X4-IZ
5	Clamp	OPIV160-X
6	Straight pipe	RPD100/160/500-KS-X4-IZ
7	Intermediate support	PPD100/160-KS-X4-IZ
8	Mounting bracket	OMD-II-160-X/50-150
9	Fastening clamp	OPIII100/160-KS-X-IZ
10	Mouthpiece	USD100/160-KS-X4-IZ
11	Straight pipe	RPD100/160/500-KS-X4-IZ
12	Tee plug	ZTD100/160-KS-X4-IZ

1. STRAIGHT PIPE RPD

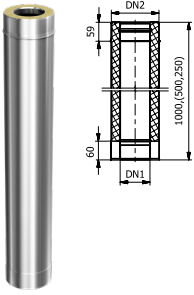

Diameter DN1/DN2	60	80	100	130	150	160	180	200	250
Diameter DN1/DN2	120	140	160	190	210	220	240	260	310
Weight	2.60	3.10	4.10	5.20	6.20	6.55	7.10	7.90	10.20

RPD DN1 / DN2 / L - KS-X ... - IZ

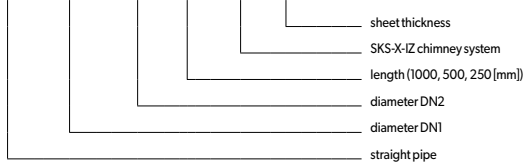

Destination	D	D - smoke ducts
	S	S - flue ducts (gas, oil)
Material	X	X - stainless steel 1.4301
Sheet thickness s	4	4 - sheet thickness 0.4 mm
	5	5 - sheet thickness 0.5 mm
	6	6 - sheet thickness 0.6 mm

* from pellet stoves

2. PIPE WITH MEASURING OUTLET ROPD

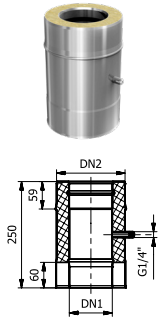

Diameter DN1/DN2	60	80	100	130	150	160	180	200	250
Diameter DN1/DN2	120	140	160	190	210	220	240	260	310
Weight	0.75	0.90	1.10	1.40	1.60	1.70	1.90	2.10	2.60

ROPD DN1 / DN2 / 250 - KS-X ... - IZ

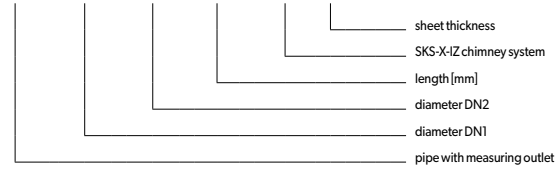

Destination	D	D - smoke ducts
	S	S - flue ducts (gas, oil)
Material	X	X - stainless steel 1.4301
Sheet thickness s	4	4 - sheet thickness 0.4 mm
	5	5 - sheet thickness 0.5 mm
	6	6 - sheet thickness 0.6 mm

* from pellet stoves

3. PIPE WITH REVISION RPDR

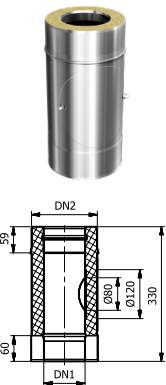

Diameter DN1/DN2	60	80	100	130	150	160	180	200	250
Diameter DN1/DN2	120	140	160	190	210	220	240	260	310
Weight	1.00	1.10	1.50	1.80	2.10	2.20	2.50	2.70	3.50

RPDR DN1 / DN2 - KS-X ... - IZ

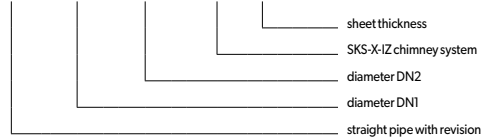

Destination	D	D - smoke ducts
	S	S - flue ducts (gas, oil)
Material	X	X - stainless steel 1.4301
Sheet thickness s	4	4 - sheet thickness 0.4 mm
	5	5 - sheet thickness 0.5 mm
	6	6 - sheet thickness 0.6 mm

* from pellet stoves

4. TEE 90° TRD/90

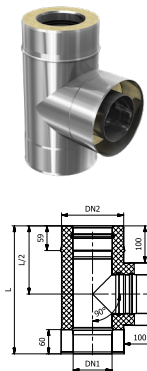

Diameter DN1/DN2	60	80	100	130	150	160	180	200	250
Diameter DN1/DN2	120	140	160	190	210	220	240	260	310
L [mm]	320	340	360	390	410	420	440	460	510
Weight	1.10	1.40	1.90	2.50	3.10	3.40	3.80	4.40	6.30

TRD DN1 / DN2 / 90 - KS-X ... - IZ

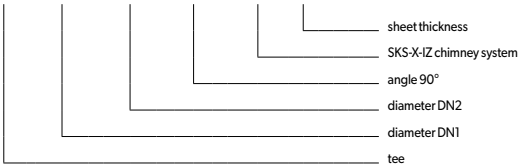

Destination	D	D - smoke ducts
	S	S - flue ducts (gas, oil)
Material	X	X - stainless steel 1.4301
Sheet thickness s	4	4 - sheet thickness 0.4 mm
	5	5 - sheet thickness 0.5 mm
	6	6 - sheet thickness 0.6 mm

* from pellet stoves

5. TEE 45° TRD/45



Diameter DN1/DN2	60	80	100	130	150	160	180	200	250
L [mm]	370	420	425	470	500	510	540	570	640
m [mm]	125	129	133	140	145	147	150	155	166
Weight	1.20	1.60	2.10	2.90	3.70	4.00	4.60	5.30	7.50

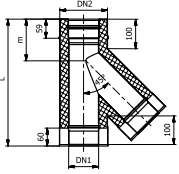

TRD DN1 / DN2 / 45 - KS-X ... - IZ

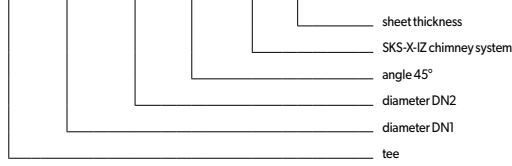

Destination	D	D - smoke ducts
	S	S - flue ducts (gas, oil)
Material	X	X - stainless steel 1.4301
	4	4 - sheet thickness 0.4 mm
Sheet thickness s	5	5 - sheet thickness 0.5 mm
	6	6 - sheet thickness 0.6 mm

* from pellet stoves

6. CONDENSATE DRAIN BOWL MSD

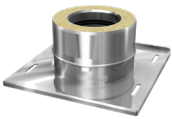

Diameter DN1/DN2	60	80	100	130	150	160	180	200	250
A [mm]	210	240	260	300	300	325	325	350	400
Weight	1.00	1.20	1.50	2.00	2.20	2.40	2.90	3.00	4.00

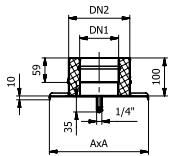

MSD DN1 / DN2 - KS-X ... - IZ

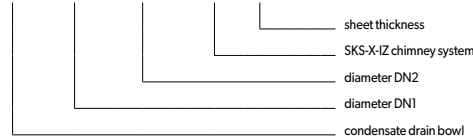

Destination	D	D - smoke ducts
	S	S - flue ducts (gas, oil)
Material	X	X - stainless steel 1.4301
	4	4 - sheet thickness 0.4 mm
Sheet thickness s	5	5 - sheet thickness 0.5 mm
	6	6 - sheet thickness 0.6 mm

* from pellet stoves

7. TEE PLUG ZTD



Diameter DN1/DN2	60	80	100	130	150	160	180	200	250
Weight	0.30	0.35	0.38	0.40	0.40	0.45	0.50	0.55	0.70

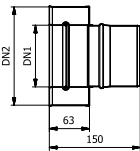

ZTD DN1 / DN2 - KS-X ... - IZ

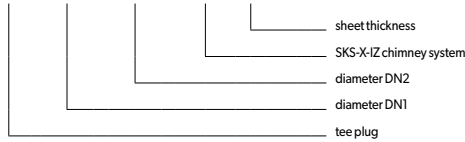

Destination	D	D - smoke ducts
	S	S - flue ducts (gas, oil)
Material	X	X - stainless steel 1.4301
	4	4 - sheet thickness 0.4 mm
Sheet thickness s	5	5 - sheet thickness 0.5 mm
	6	6 - sheet thickness 0.6 mm

* from pellet stoves

8. INTERMEDIATE SUPPORT PPD

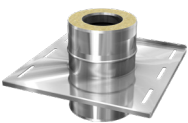

Diameter DN1/DN2	60	80	100	130	150	160	180	200	250
Weight	1.50	1.80	2.10	2.10	2.60	2.90	3.00	3.60	4.45

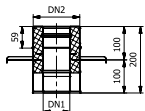

PPD DN1 / DN2 - KS-X ... - IZ

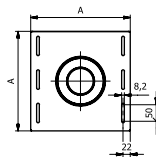
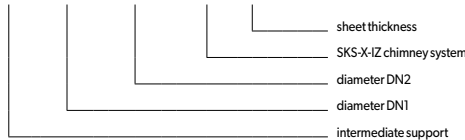

Destination	D	D - smoke ducts
	S	S - flue ducts (gas, oil)
Material	X	X - stainless steel 1.4301
	4	4 - sheet thickness 0.4 mm
Sheet thickness s	5	5 - sheet thickness 0.5 mm
	6	6 - sheet thickness 0.6 mm

* from pellet stoves

9. INTERMEDIATE SUPPORT PJD

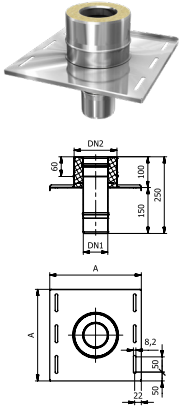

Diameter DN1/DN2	60	80	100	130	150	160	180	200	250
		120	140	160	190	210	220	240	260
Weight	1.30	1.60	1.80	2.00	2.40	2.60	2.70	3.30	4.10

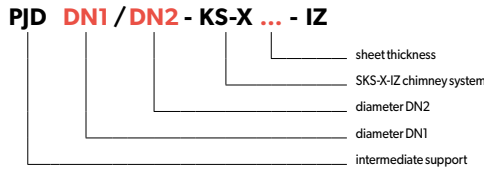

Destination	D	D - smoke ducts
	S	S - flue ducts (gas, oil)
Material	X	X - stainless steel 1.4301
	4	4 - sheet thickness 0.4 mm
Sheet thickness s	5	5 - sheet thickness 0.5 mm
	6	6 - sheet thickness 0.6 mm

* from pellet stoves

10. REDUCER RDD

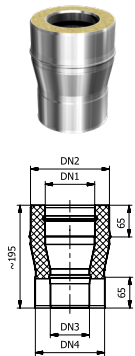

Diameter DN1/DN2	60	80	100	130	150	160	180	200	250
		120	140	160	190	210	220	240	260
Weight	0.40	0.50	0.60	0.80	1.00	1.00	1.10	1.20	1.60

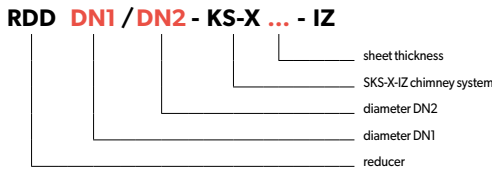

Destination	D	D - smoke ducts
	S	S - flue ducts (gas, oil)
Material	X	X - stainless steel 1.4301
	4	4 - sheet thickness 0.4 mm
Sheet thickness s	5	5 - sheet thickness 0.5 mm
	6	6 - sheet thickness 0.6 mm

* from pellet stoves

11. ANGULAR ROOF FLASHING PDK

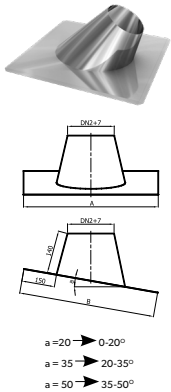

Diameter DN1/DN2	60	80	100	130	150	160	180	200	250	
		120	140	160	190	210	220	240	260	310
α 20	A	525	555	575	605	625	635	640	680	735
	B	525	555	575	605	625	635	640	680	735
α 35	A	545	575	595	630	650	670	690	720	775
	B	580	610	630	675	700	715	740	765	835
α 50	A	580	610	640	680	710	715	750	770	835
	B	690	725	760	810	850	870	910	950	1000

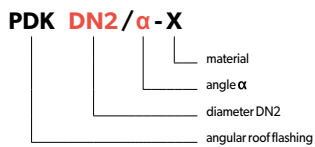

Destination	D	D - smoke ducts
	S	S - flue ducts (gas, oil)
Material	X	X - stainless steel 1.4301
	4	4 - sheet thickness 0.4 mm
Sheet thickness	6	6 - sheet thickness 0.6 mm

12. RAIN COLLAR KPD

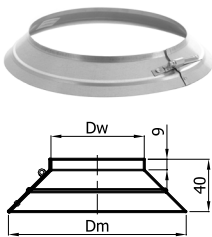

Diameter DN	ø80	ø100	ø110	ø120	ø125	ø130	ø140	ø150	ø160	ø180	ø200	ø225	ø250	ø300	ø350	ø400	ø450	ø500
Dw [mm]	79.0	99.7	110.9	122.0	126	131.6	139.5	150.7	160.2	180.9	200.0	225.5	251.0	300.4	349.7	400.7	450.0	501.0
Dm [mm]	151	172	183	194	200	204	212	223	232	253	272	326	350	400	450	501	550	601
Weight [kg]	0.14	0.16	0.17	0.18	0.18	0.18	0.19	0.20	0.21	0.23	0.25	0.29	0.31	0.36	0.41	0.45	0.50	0.54

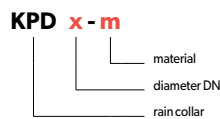

Destination	W	W	W - ventilation
	X	-	X - stainless steel 1.4301
Material	-	OC	OC - galvanised steel sheet
	5	5	5 - sheet thickness 0.5 mm
Sheet thickness s	6	-	6 - sheet thickness 0.6 mm
	-	7	7 - sheet thickness 0.75 mm
	8	-	8 - sheet thickness 0.8 mm
	1	1	1 - sheet thickness 1.0 mm

13. CAP DKD

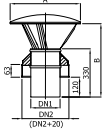

Diameter DN1/DN2	60	80	100	130	150	160	180	200	250
D [mm]	160	160	220	250	290	290	290	350	400
B [mm]	410	410	410	410	430	430	430	450	630
Weight	1.10	1.30	1.50	1.70	1.90	2.00	2.20	2.30	3.60

DKD DN1 / DN2 - KS-X ... - IZ

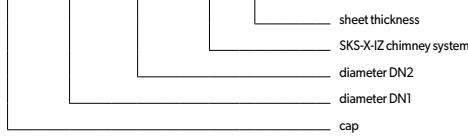

Destination	D	D - smoke ducts
	S	S - flue ducts (gas, oil)
Material	X	X - stainless steel 1.4301
	4	4 - sheet thickness 0.4 mm
Sheet thickness s	5	5 - sheet thickness 0.5 mm
	6	6 - sheet thickness 0.6 mm

* from pellet stoves

14. MOUTHPIECE USD

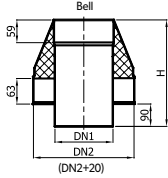

Diameter DN1/DN2	60	80	100	130	150	160	180	200	250
H [mm]	250	250	250	250	250	250	250	250	250
Weight	0.60	0.70	0.80	0.90	1.10	1.20	1.30	1.40	1.90

USD DN1 / DN2 - KS-X ... - IZ

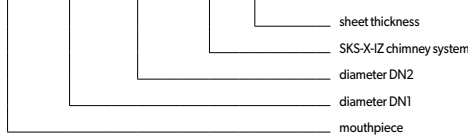

Destination	D	D - smoke ducts
	S	S - flue ducts (gas, oil)
Material	X	X - stainless steel 1.4301
	4	4 - sheet thickness 0.4 mm
Sheet thickness s	5	5 - sheet thickness 0.5 mm
	6	6 - sheet thickness 0.6 mm

* from pellet stoves

15. SOLID ELBOW 90° KSD/90

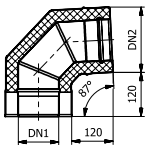

Diameter DN1/DN2	60	80	100	130	150	160	180	200	250
Weight	0.90	1.20	1.50	2.00	2.50	2.70	3.10	3.60	4.90

KSD DN1 / DN2 / 90 - KS-X ... - IZ

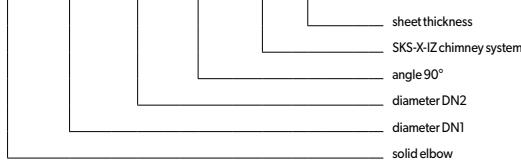

Destination	D	D - smoke ducts
	S	S - flue ducts (gas, oil)
Material	X	X - stainless steel 1.4301
	4	4 - sheet thickness 0.4 mm
Sheet thickness s	5	5 - sheet thickness 0.5 mm
	6	6 - sheet thickness 0.6 mm

* from pellet stoves

16. SOLID ELBOW 45° KSD/45

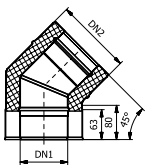
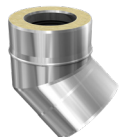

Diameter DN1/DN2	60	80	100	130	150	160	180	200	250
Weight	0.50	0.70	0.90	1.20	1.50	1.60	1.80	2.10	2.90

KSD DN1 / DN2 / 45 - KS-X ... - IZ

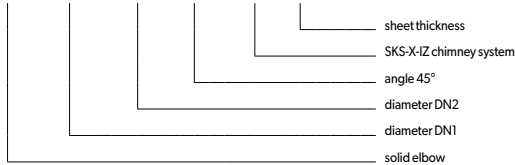

Destination	D	D - smoke ducts
	S	S - flue ducts (gas, oil)
Material	X	X - stainless steel 1.4301
	4	4 - sheet thickness 0.4 mm
Sheet thickness s	5	5 - sheet thickness 0.5 mm
	6	6 - sheet thickness 0.6 mm

* from pellet stoves

17. SOLID ELBOW 30° KSD/30



Diameter DN1/DN2	60	80	100	130	150	160	180	200	250
Weight	0.50	0.70	0.90	1.20	1.50	1.60	1.80	2.10	2.90

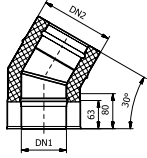

KSD DN1 / DN2 / 30 - KS-X ... - IZ

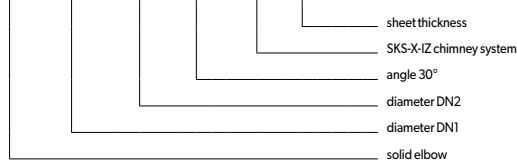

Destination	D	D - smoke ducts
	S	S - flue ducts (gas, oil)
Material	X	X - stainless steel 1.4301
	4	4 - sheet thickness 0.4 mm
Sheet thickness s	5	5 - sheet thickness 0.5 mm
	6	6 - sheet thickness 0.6 mm

* from pellet stoves

18. SOLID ELBOW 90° WITH SUPPORT KSDW/90

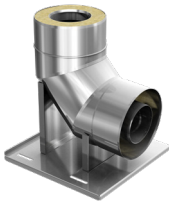

Diameter DN1/DN2	60	80	100	130	150	160	180	200	250
A [mm]	240	240	260	300	300	325	325	350	400
Weight	1.20	1.40	1.50	2.30	2.80	3.00	3.40	3.90	5.20

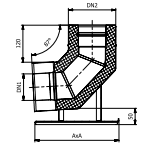

KSDW DN1 / DN2 / 90 - KS-X ... - IZ

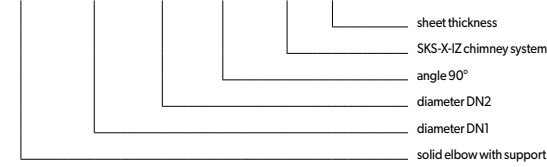

Destination	D	D - smoke ducts
	S	S - flue ducts (gas, oil)
Material	X	X - stainless steel 1.4301
	4	4 - sheet thickness 0.4 mm
Sheet thickness s	5	5 - sheet thickness 0.5 mm
	6	6 - sheet thickness 0.6 mm

* from pellet stoves

19. FASTENING CLAMP OP I



Diameter DN2	120	140	160	190	210	220	240	260	310
Weight [kg]	0.20	0.21	0.22	0.24	0.25	0.30	0.34	0.36	0.41

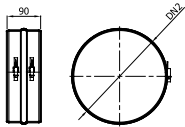

OPI DN2 - X

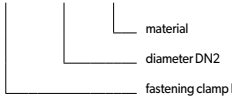

Destination	D	D - smoke ducts
	S	S - flue ducts (gas, oil)
Material	X	X - stainless steel 1.4301
	4	4 - sheet thickness 0.4 mm
Sheet thickness	6	6 - sheet thickness 0.6 mm

20. FASTENING CLAMP OP II



Diameter DN2	120	140	160	190	210	220	240	260	310
Weight [kg]	0.13	0.14	0.15	0.16	0.17	0.19	0.20	0.22	0.26

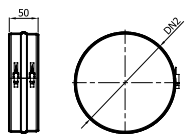

OPII DN2 - X

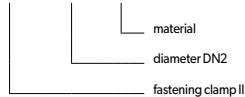

Destination	D	D - smoke ducts
	S	S - flue ducts (gas, oil)
Material	X	X - stainless steel 1.4301
	4	4 - sheet thickness 0.4 mm
Sheet thickness	6	6 - sheet thickness 0.6 mm

21. FASTENING CLAMP OP IV



Diameter DN2	120	140	160	190	210	220	240	260	310
Weight [kg]	0.25	0.30	0.30	0.35	0.35	0.40	0.40	0.40	0.50

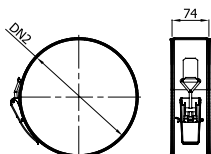

OPIV DN2 - X

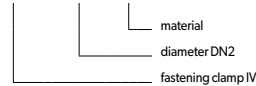

Destination	D	D - smoke ducts
	S	S - flue ducts (gas, oil)
Material	X	X - stainless steel 1.4301
	4	4 - sheet thickness 0.4 mm
Sheet thickness	6	6 - sheet thickness 0.6 mm

22. MOUNTING BRACKET OMD-II

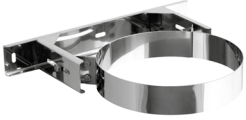

Diameter DN2	120	125	140	160	190	210	220	225	240	250	260	280	3600	310	3325	350	400	450	500	550	600
A [mm]	322	327	339	354	380	380	395	395	409	409	415	424	433	433	445	456	476	556	580	608	634
Weight [kg]	1.00	1.00	1.04	1.08	1.14	1.15	1.20	1.20	1.23	1.24	1.26	1.29	1.33	1.35	1.37	1.41	1.49	1.98	2.10	2.60	2.71

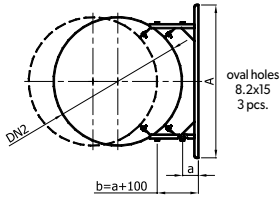

OMD-II DN2 - X/ 5-15



Destination	D	D - smoke ducts
	S	S - flue ducts (gas, oil)
Material	X	X - stainless steel 1.4301

23. SUPPORTING CONSOLE KWD



Diameter DN2	120	125	140	160	190	210	220	225	240	250	260	280	300	310	325	350	400	450	500	550	600
A [mm]	231	231	254	254	304	304	304	304	354	354	354	384	404	404	429	454	504	552	604	654	701
Weight [kg]	1.70	1.70	2.00	2.00	2.60	2.60	2.70	2.70	3.25	3.25	3.25	3.70	4.20	4.20	4.65	5.10	6.05	7.10	8.20	9.40	10.65

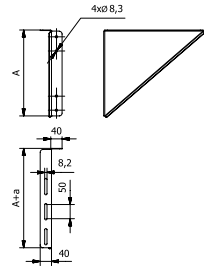

KWD DN2 - X/a-(a+100)

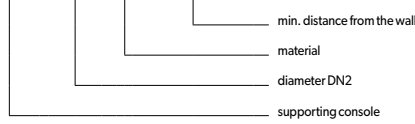

Destination	D	D - smoke ducts
	S	S - flue ducts (gas, oil)
Material	X	X - stainless steel 1.4301
Sheet thickness	2	2 - sheet thickness 2.0 mm

24. LATERAL OUTLET 0.22 [m] WBD

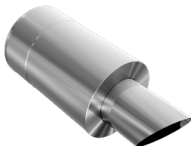

Diameter DN1 / DN2	60	80	100	130	150	160	180	200	250
	120	140	160	190	210	220	240	260	310
Weight	0.60	0.80	1.00	1.20	1.60	1.70	1.90	2.00	2.50

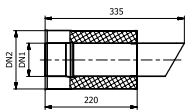

WBD DN1 / DN2 - KS-X ... - IZ

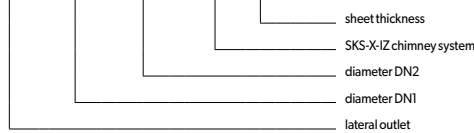

Destination	D	D - smoke ducts
	S	S - flue ducts (gas, oil)
Material	X	X - stainless steel 1.4301
Sheet thickness s	4	4 - sheet thickness 0.4 mm
	5	5 - sheet thickness 0.5 mm
	6	6 - sheet thickness 0.6 mm

* from pellet stoves