

Chimney connections for accumulation systems <SPKA>

Chimney connections are made of chrome-nickel heat-resistant steel sheet (type 1.4828 according to DIN 17441) of thickness 2.0 mm. Their application is fume extraction from stoves, where fumes temperature can rise up even to 1200°C.

Chimney connection elements <SPKA> can not be used to build a chimney duct. Elements of system are plasma welded, bell pipe joining.

Certificate of Factory Production Control 1450-CPR-0007 issued by INiG Cracow.

Bell joint pipe connection

Individual elements of the chimney connection system are being joint by the way of pushing one part of the element - specially press-formed (a spigot), into the other, not prefabricated part of the element. Thanks to this type of pipe joining, chimney liner is characterized by very tight and stiff construction. It also assures proper flow of exhaust fumes from stove to the chimney. Elements should be connected with the press-formed (shrunk) part up.



<SPKA>

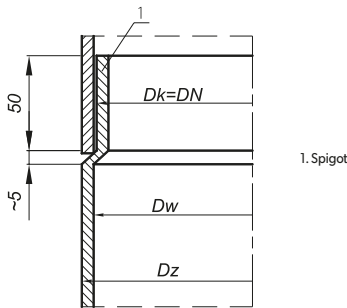

Fig. Method of joining chimney connection pipe elements

Table of layouts and sizes

Diameter DN	Lr	Dz	Dw	Dk=DN
150	481	155	151	150
160	512	165	161	160
180	575	185	181	180
200	638	205	201	200

Measurments

- Lr - metal sheet layout [mm]±0.1
- Dz - outer diameter of pipe [mm]
- Dw - inner diameter of pipe [mm]
- Dk - inner diameter of spigot [mm]

Destination

- D - smoke ducts

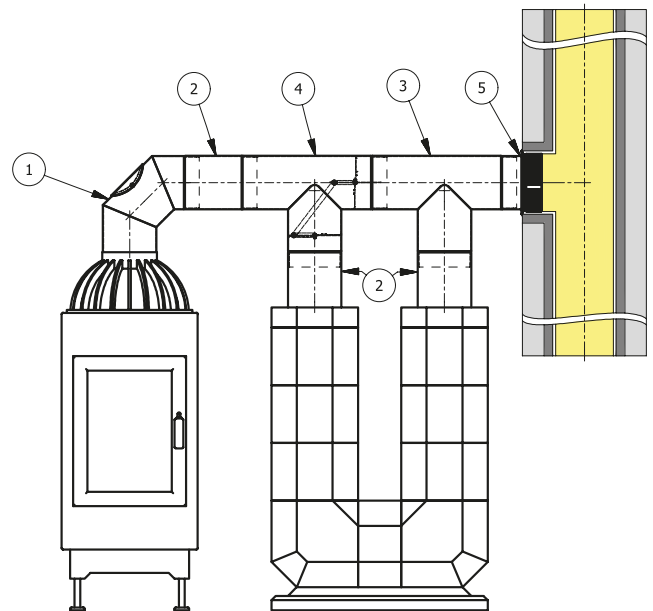

No	Name	Denotation
1	Solid elbow with revision 90°	KSR180/90-Z2
2	Straight pipe 250 [mm]	RP180/250-Z2
3	Tee 90°	TR180/90-Z2
4	Twin-flow tee	TRM180/90-Z2
5	Wall insert to ceramic chimneys	WKC180/200-Z2

1. STRAIGHT PIPE RPZ

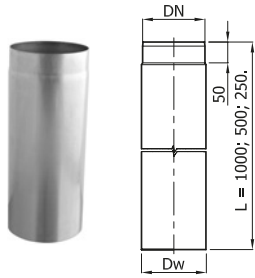

Length L	1000				500				250			
Diameter DN	ø150	ø160	ø180	ø200	ø150	ø160	ø180	ø200	ø150	ø160	ø180	ø200
Dw	151.0	161.0	181.0	201.0	151.0	161.0	181.0	201.0	151.0	161.0	181.0	201.0
Weight [kg]	7.80	8.20	9.20	10.40	3.80	4.10	4.60	5.20	1.90	2.10	2.30	2.60

RPZ x/L - Z 2

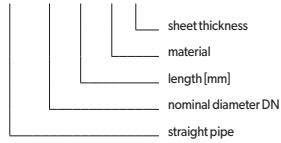

Destination	D	D - smoke ducts
Material	Z	Z - heat resistant steel 1.4828
Sheet thickness s	2	2 - sheet thickness 2.0 mm

2. SOLID ELBOW 90° WITH REVISION KSRZ/90

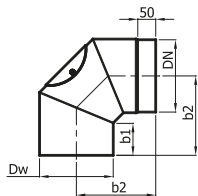

Diameter DN	ø150	ø160	ø180	ø200
Dw [mm]	151.0	161.0	181.0	201.0
b1 [mm]	95.0	95.0	87.0	84.0
b2 [mm]	235.0	235.0	235.0	235.0
Weight [kg]	3.40	3.60	4.00	4.40

KSRZ x/90 - Z 2

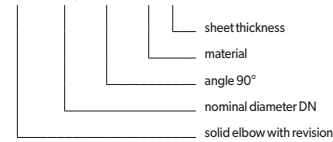

Destination	D	D - smoke ducts
Material	Z	Z - heat resistant steel 1.4828
Sheet thickness s	2	2 - sheet thickness 2.0 mm

3. SOLID ELBOW 45° WITH REVISION KSRZ/45

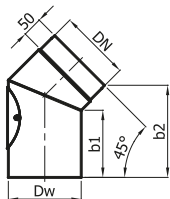

Diameter DN	ø150	ø160	ø180	ø200
Dw [mm]	151.0	161.0	181.0	201.0
b1 [mm]	172.0	168.0	168.0	162.0
b2 [mm]	243.0	238.0	233.0	225.0
Weight [kg]	2.80	3.00	3.20	3.40

KSRZ x/45 - Z 2

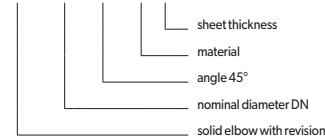

Destination	D	D - smoke ducts
Material	Z	Z - heat resistant steel 1.4828
Sheet thickness s	2	2 - sheet thickness 2.0 mm

4. TWIN-FLOW TEE TRZMr/90 WITH REVISION

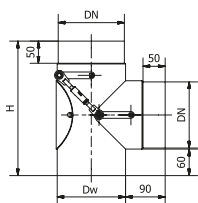

Diameter DN	ø150	ø160	ø180	ø200
Dw [mm]	151.0	161.0	181.0	201.0
H [mm]	305.0	315.0	335.0	355.0
Weight [kg]	4.00	4.40	5.10	6.00

TRZMr x / 90 - Z 2



Destination	D	D - smoke ducts
Material	Z	Z - heat resistant steel 1.4828
Sheet thickness s	2	2 - sheet thickness 2.0 mm

5. TEE 90° TRZ/90

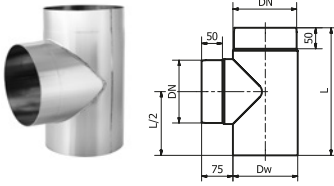

Diameter DN	ø150	ø160	ø180	ø200
Dw [mm]	151.0	161.0	181.0	201.0
L [mm]	305.0	315.0	335.0	355.0
Weight [kg]	2.70	3.00	3.50	4.00

TRZ x/90 - Z 2

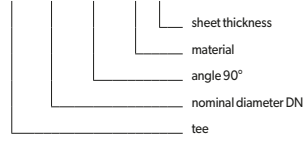

Destination	D	D - smoke ducts
Material	Z	Z - heat resistant steel 1.4828
Sheet thickness s	2	2 - sheet thickness 2.0 mm

6. TIGHT CHIMNEY DAMPER SZKZsz



Diameter DN	ø150	ø160	ø180	ø200
Dw [mm]	151.0	161.0	181.0	201.0
L [mm]	210.0	220.0	240.0	260.0
H [mm]	170.0	180.0	200.0	220.0
Weight [kg]	1.77	1.98	2.45	2.97

SZKZsz ... - Z2-8x8

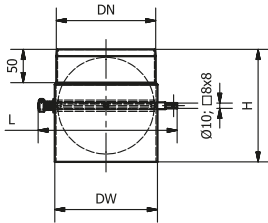
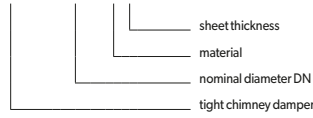

Destination	D	D - smoke ducts
Material	Z	Z - heat resistant steel 1.4828
Sheet thickness s	2	2 - sheet thickness 2.0 mm

Additional devices - see page 186.

7. WALL INSERT TO CERAMIC CHIMNEYS WKCZ

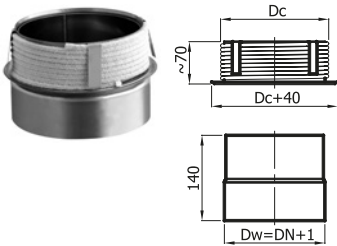

Diameters	DN	ø150	ø160	ø180
	DC	ø160	ø180	ø200
Weight [kg]		1.30	1.70	1.90

Caution! Other inserts upon individual order.

WKCZ x/y - Z 2

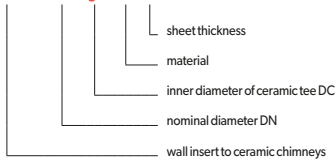

Destination	D	D - smoke ducts
Material	Z	Z - heat resistant steel 1.4828
Sheet thickness s	2	2 - sheet thickness 2.0 mm

Caution! This wall insert protects tees of ceramic chimneys from damages caused by thermal expansion of metal elements of the chimney connection.

1. CHIMNEY DAMPER KNOB SZKZ-REG, SZKZ-REG-LIGHT

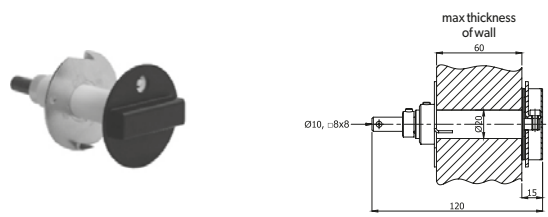
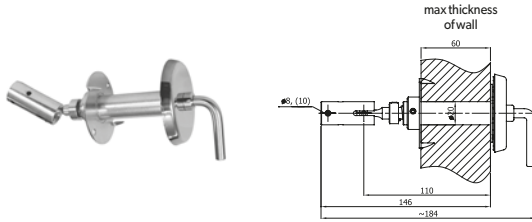

SZKZ - REG

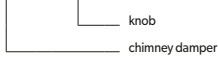

SZKZ - REG-LIGHT - ...

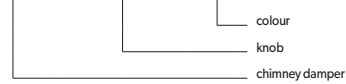

Destination	S	-	S - flue ducts
	-	D	D - smoke ducts
Material	CH	CH	CH - stainless steel 1.4301
	ML	ML	ML - stainless steel 1.4301 powder coated

Destination	S	-	S - flue ducts
	-	D	D - smoke ducts
Material	CZ	CZ	CZ - steel sheet (black)
	B	B	B - white
Colour	B	B	B - white
	CZ	CZ	CZ - black

2. ROUND AND RECTANGULAR UNDER SURFACE CHIMNEY DAMPER KNOBS

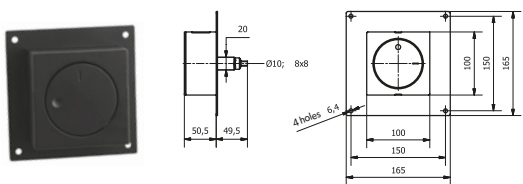
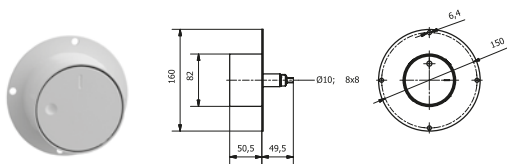

SZKZ - REG-OK - ML ...

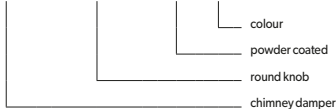

SZKZ - REG-KW - ML ...



Destination	S	-	S - flue ducts
	-	D	D - smoke ducts
Material	CZ	CZ	CZ - steel sheet (black)
	B	B	B - white
Colour	B	B	B - white
	CZ	CZ	CZ - black

3. CHIMNEY DAMPER ... OS (ON SURFACE AND UNDER SURFACE VERSION)

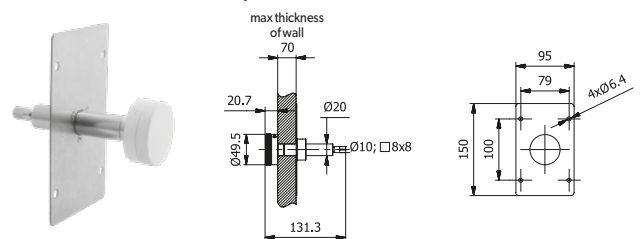
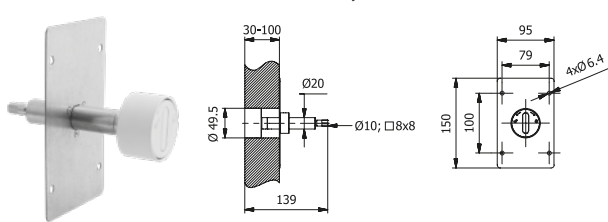

SZKZ - REG-OS/P - ML - ...

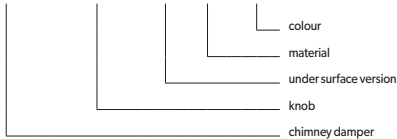

SZKZ - REG-OS/N - ML - ...

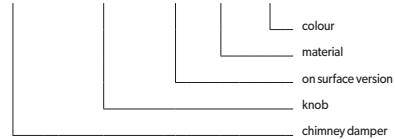

Destination	S	-	S - flue ducts
	-	D	D - smoke ducts
Material	ML	ML	ML - aluminium powder coated
	B	B	B - white
Colour	B	B	B - white
	CZ	CZ	CZ - black

4. CHIMNEY DAMPER KNOB

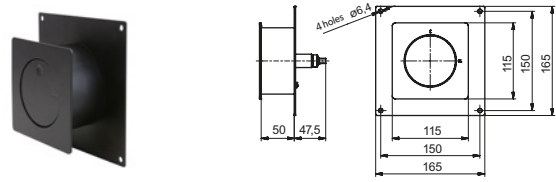
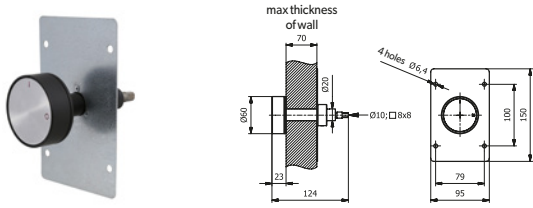

SZKZV - REG1-OS / N - ML - ...

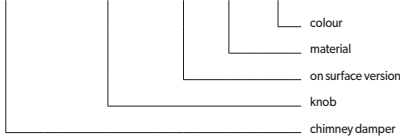

SZKZV - REG2-KW / P - ML - ...

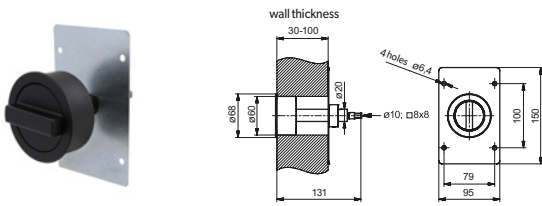
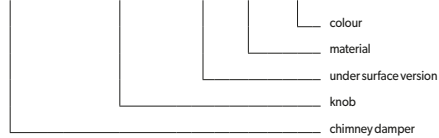

SZKZV - REG3-LIGHT - ML - ...

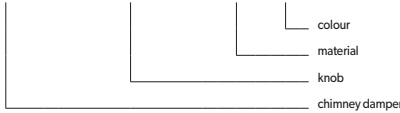

Destination	S	-	S - flue ducts
	-	D	D - smoke ducts
Material	ML	ML	ML - aluminium powder coated
	B	B	B - white
Colour	CZ	CZ	CZ - black

5. FLEXIBLE SHAFT SZK-REG-WG, SZKZ-REG-WGSZ, EXTENSION OF FLEXIBLE SHAFT SZKZ-REG-PW600

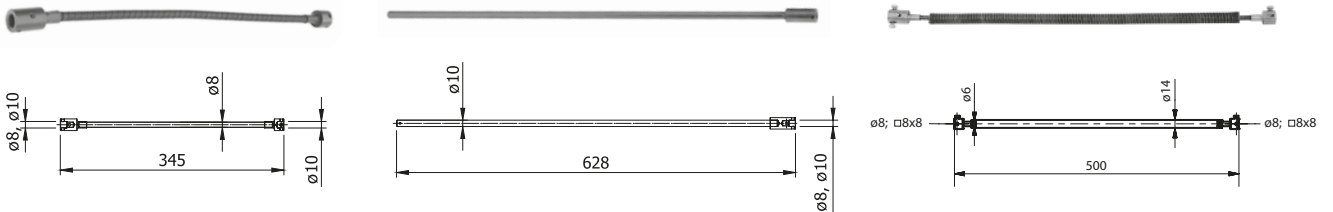

SZK-REG-WG

flexible shaft

SZKZ-REG-PW600

extension of flexible shaft

SZKZ-REG-WGSZ

flexible shaft with cover

Destination	S	-	S - flue ducts
	-	D	D - smoke ducts
Material	CZ	CZ	CZ - steel sheet (black)

Compatible with chimney dampers with rod diameters 8 and 10 mm and knobs produced by DARCO.

6. ROUND, SQUARE JOINT

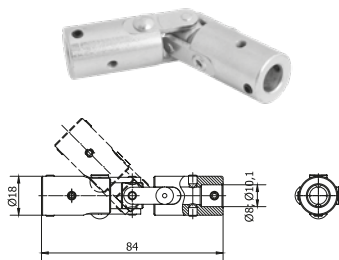

SZKZ-REG-PGO

round joint

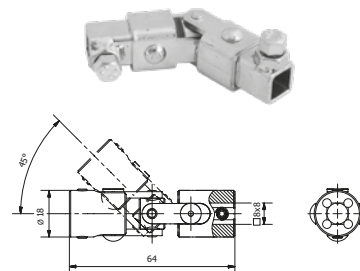

SZKZ-REG-PGK

square joint