

Chimney connections for pellet stoves <SPKP>

Chimney connections for pellet stoves are made of mild steel sheet type DC01, thickness 1.2 mm. Their application is smoke extraction from pellet stoves, where fumes temperature can rise to 250°C. Maximum working temperature: 250°C.

Bell joint pipe connection

Individual elements of the chimney system are being joint by the way of pushing one part of the element - a spigot, into the other press-formed part of the element - a bell. Thanks to this type of pipe joining, chimney connection is characterized by very tight and stiff construction. It also assures proper flow of condensate. In order to prevent fumes from leaking out, special silicone seals are used in the bell joint of the pipe. Elements are powder coated with special high temperature paint (400°C) in black matt colour.

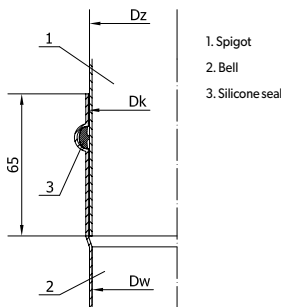

Fig. Method of joining chimney connection pipe elements <SPKP>



Table of layouts and sizes

Diameter DN	Dz	Dw	Dk
80	80.1	77.7	81.1
100	100.2	97.8	101.2

Measurments

- Dz - outer diameter of pipe [mm]
- Dw - inner diameter of pipe [mm]
- Dk - outer diameter of spigot [mm]

Destination

- D - smoke ducts

Model of application of elements

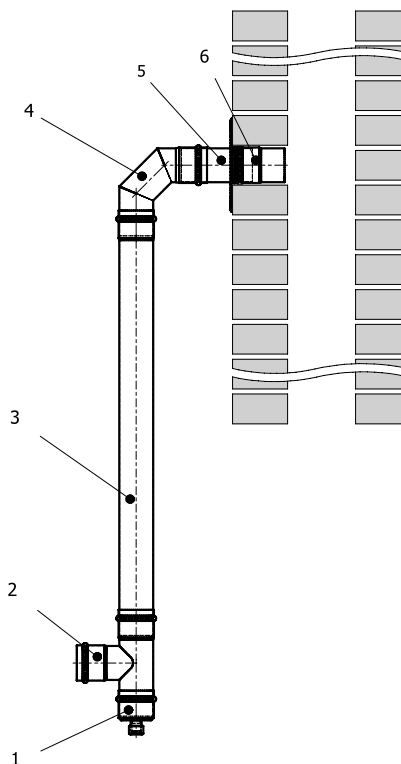
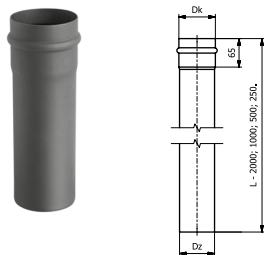

Fig. Example of chimney connection SPKP system

No	Name	Denotation
1	Drain bowl	MS80-CZ1,2P
2	Tee 90°	TR80/90-CZ1,2P
3	Straight pipe 1000 [mm]	RP80/100-CZ1,2P
4	Solid elbow 90°	KS80/90-CZ1,2P
5	Male connector	ZM80-CZ1,2P
6	Rosette	ROZ80-CZ1,2P

1. STRAIGHT PIPE 1000, 500, 250 [mm] RP



Length L	1000		500		250	
Diameter DN	ø80	ø100	ø80	ø100	ø80	ø100
Dz	80.1	100.2	80.1	100.2	80.1	100.2
Dk	81.1	101.2	81.1	101.2	81.1	101.2
Weight [kg]	2.40	2.95	1.20	1.50	0.60	0.75

RP x/L - CZ 1,2P

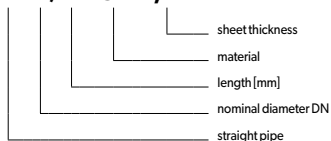

Destination	D	D - smoke ducts
Material	CZ	CZ - mild steel DC01
Sheet thickness	1.2	1.2 - sheet thickness 1.2 mm

2. TELESCOPIC PIPE RT

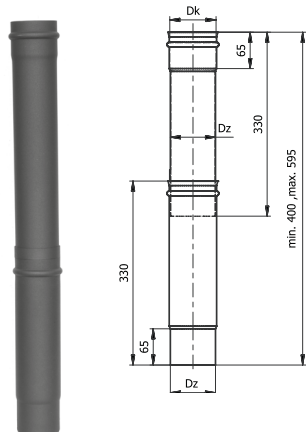

RT x/2x0,33 - CZ 1,2P

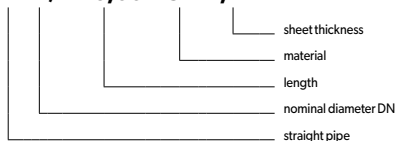

Diameter DN	ø80	ø100
Dz	80.1	100.2
Dk	81.1	101.2
Weight [kg]	1.7	2.1

Destination	D	D - smoke ducts
Material	CZ	CZ - mild steel DC01
Sheet thickness	1.2	1.2 - sheet thickness 1.2 mm

3. STRAIGHT PIPE WITH MEASURING OUTLET ROP

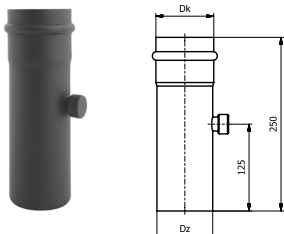

ROP x/0,25 - CZ 1,2P

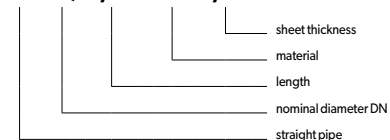

Diameter DN	ø80	ø100
Dz	80.1	100.2
Dk	81.1	101.2
Weight [kg]	0.7	0.9

Destination	D	D - smoke ducts
Material	CZ	CZ - mild steel DC01
Sheet thickness	1.2	1.2 - sheet thickness 1.2 mm

4. SOLID ELBOW 90° KS/90

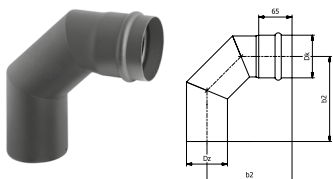

KS x/ 90 - CZ 1,2P

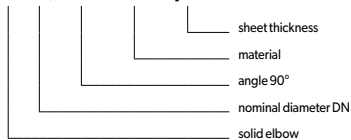

Diameter DN	ø80	ø100
Dz [mm]	80.1	100.2
Dk [mm]	81.1	101.2
b1 [mm]	83.0	79.0
b2 [mm]	166.0	165.0
Weight [kg]	0.70	0.90

Destination	D	D - smoke ducts
Material	CZ	CZ - mild steel DC01
Sheet thickness	1.2	1.2 - sheet thickness 1.2 mm

5. SOLID ELBOW 90° - 2SEG

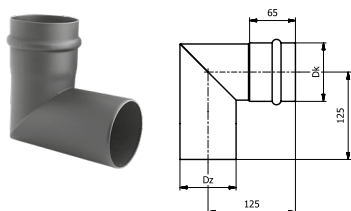

KS x/ 90 - CZ 1,2P-2SEG

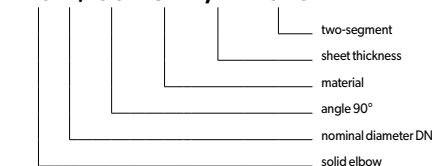

Diameter DN	ø80	ø100
Dz [mm]	80.1	100.2
Dk [mm]	81.1	101.2
Weight [kg]	0.6	0.75

Destination	D	D - smoke ducts
Material	CZ	CZ - mild steel DC01
Sheet thickness	1.2	1.2 - sheet thickness 1.2 mm

6. SOLID ELBOW 90° SPIGOT - SPIGOT

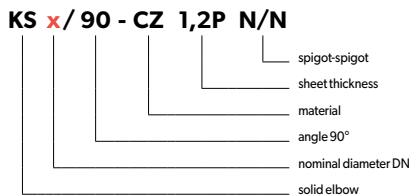
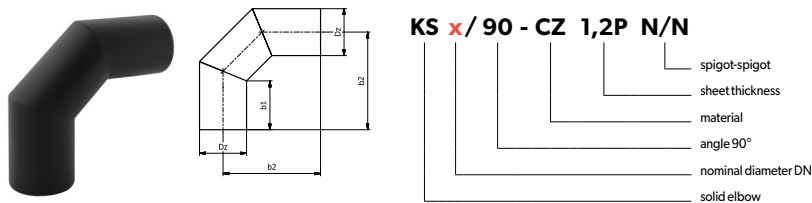

Diameter DN	ø80	ø100
Dz [mm]	80.1	100.2
b1 [mm]	83	79
b2 [mm]	166	165
Weight [kg]	0.70	0.90

Destination	D	D - smoke ducts
Material	CZ	CZ - mild steel DC01
Sheet thickness	1.2	1.2 - sheet thickness 1.2 mm

7. SOLID ELBOW 90° WITH REVISION KSR/90

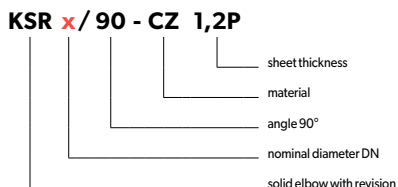
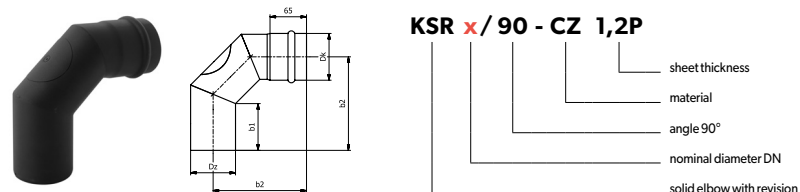

Diameter DN	ø80	ø100
Dz [mm]	80.1	100.2
Dk [mm]	81.1	101.2
b1 [mm]	83.0	79.0
Weight [kg]	0.80	1.00

Destination	D	D - smoke ducts
Material	CZ	CZ - mild steel DC01
Sheet thickness	1.2	1.2 - sheet thickness 1.2 mm

8. SOLID ELBOW 45° KS/45

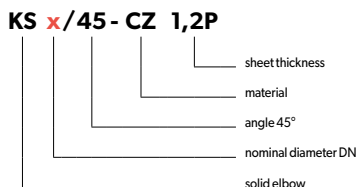
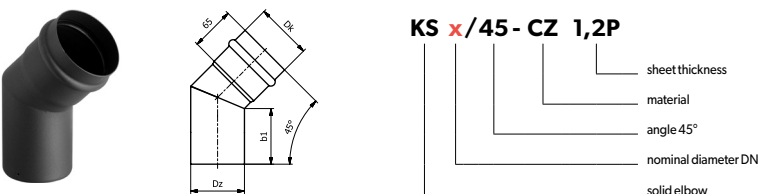

Diameter DN	ø80	ø100
Dz [mm]	80.1	100.2
Dk [mm]	81.1	101.2
b1 [mm]	83.0	79.0
Weight [kg]	0.50	0.65

Destination	D	D - smoke ducts
Material	CZ	CZ - mild steel DC01
Sheet thickness	1.2	1.2 - sheet thickness 1.2 mm

9. SOLID ELBOW 45° WITH REVISION KSR/45

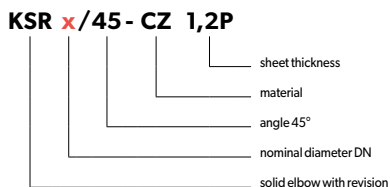
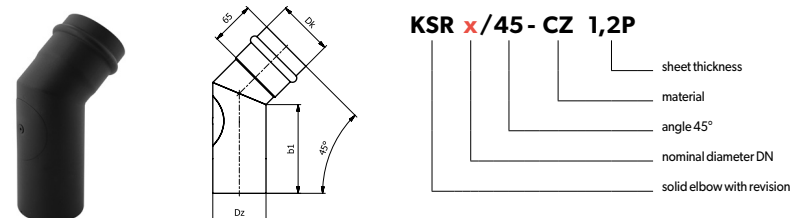

Diameter DN	ø80	ø100
Dz [mm]	80.1	100.2
Dk [mm]	81.1	101.2
b1 [mm]	133	129
Weight [kg]	1.0	1.2

Destination	D	D - smoke ducts
Material	CZ	CZ - mild steel DC01
Sheet thickness	1.2	1.2 - sheet thickness 1.2 mm

10. TEE 90° TR/90

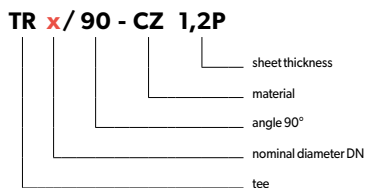
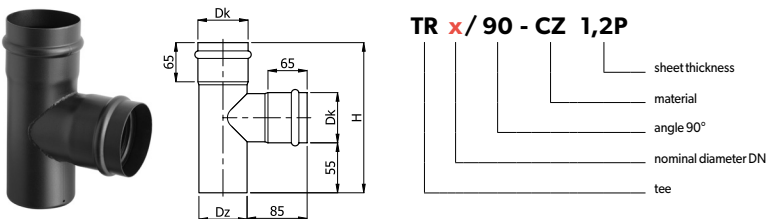

Diameter DN	ø80	ø100
Dz [mm]	80.1	100.2
Dk [mm]	81.1	101.2
H [mm]	220	240
Weight [kg]	0.85	1.15

Destination	D	D - smoke ducts
Material	CZ	CZ - mild steel DC01
Sheet thickness	1.2	1.2 - sheet thickness 1.2 mm

11. TEE WITH REVISION TRR

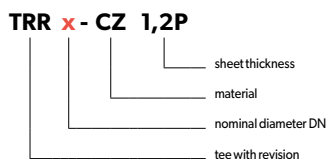
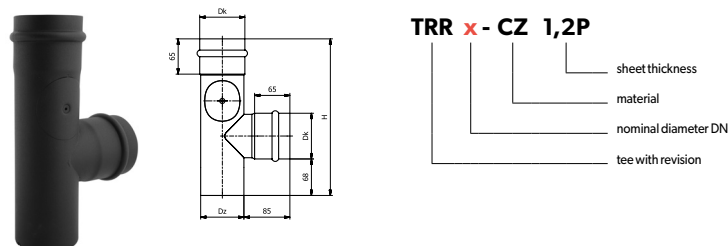

Diameter DN	ø80	ø100
Dz [mm]	80.1	100.2
Dk [mm]	81.1	101.2
H [mm]	220	240
Weight [kg]	0.95	1.25

Destination	D	D - smoke ducts
Material	CZ	CZ - mild steel DC01
Sheet thickness	1.2	1.2 - sheet thickness 1.2 mm

12. BOWL/PLUG MS

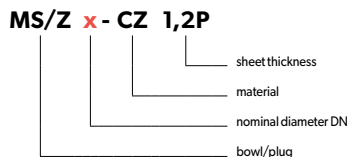
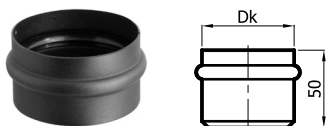

Diameter DN	ø80	ø100
Dk	81.1	101.2
Weight [kg]	0.25	0.35

Destination	D	D - smoke ducts
Material	CZ	CZ - mild steel DC01
Sheet thickness	1.2	1.2 - sheet thickness 1.2 mm

13. DRAIN BOWL MS

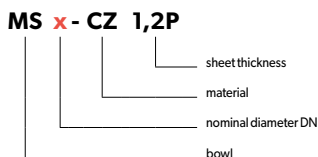
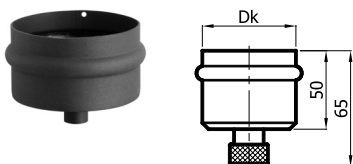

Diameter DN	ø80	ø100
Dk	81.1	101.2
Weight [kg]	0.40	0.50

Destination	D	D - smoke ducts
Material	CZ	CZ - mild steel DC01
Sheet thickness	1.2	1.2 - sheet thickness 1.2 mm

14. TEE PLUG ZT

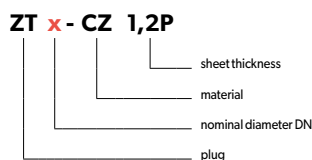
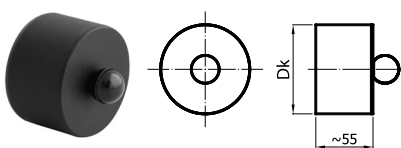

Diameter DN	ø80	ø100
Dk	81.1	101.2
Weight [kg]	0.40	0.50

Destination	D	D - smoke ducts
Material	CZ	CZ - mild steel DC01
Sheet thickness	1.2	1.2 - sheet thickness 1.2 mm

15. REDUCER RD

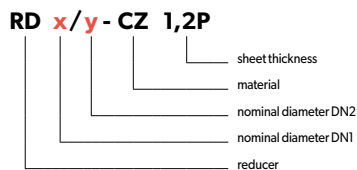
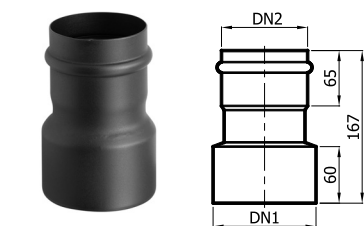

Diameter DN1/DN2	80/100	100/80
Weight [kg]	0.50	0.50

Destination	D	D - smoke ducts
Material	CZ	CZ - mild steel DC01
Sheet thickness	1.2	1.2 - sheet thickness 1.2 mm

16. ROSETTE ROZ

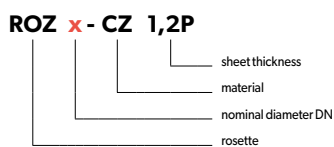
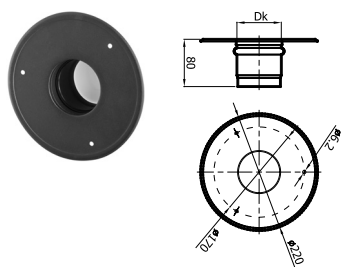

Diameter DN	ø80	ø100
Dk [mm]	80.6	100.7
Weight [kg]	0.60	0.80

Destination	D	D - smoke ducts
Material	CZ	CZ - mild steel DC01
Sheet thickness	1.2	1.2 - sheet thickness 1.2 mm

17. ROSETTE ROZII

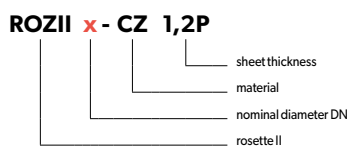
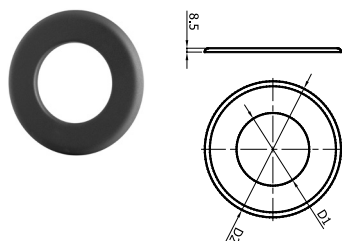

Diameter DN	ø80	ø100
D1 [mm]	80.8	100.8
D2 [mm]	150	170
Weight [kg]	0.12	0.14

Destination	D	D - smoke ducts
Material	CZ	CZ - mild steel DC01

18. SILICONE ROSETTE ROZIII

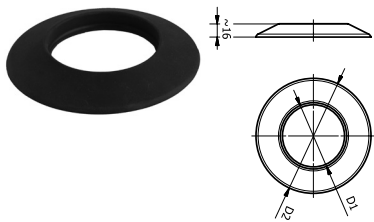

ROZIII x - CZ 1,2P / SILIKON

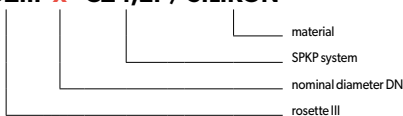

Diameter DN	ø80	ø100
D1 [mm]	79.5	99.5
D2 [mm]	138	158
Weight [kg]	0.05	0.08

Destination	D	D - smoke ducts
Material	S	S - silicone

19. FEMALE CONNECTOR ZZ

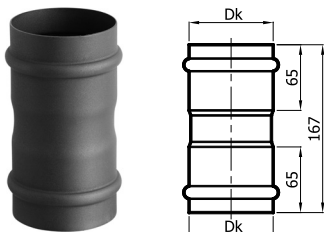

ZZ x - CZ 1,2P

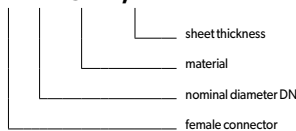

Caution!

Female connector allows to connect two spigot sided elements of the system for example due to a cut-to-size necessity.

Diameter DN	ø80	ø100
Dk	81.1	101.2
Weight [kg]	0.45	0.55

Destination	D	D - smoke ducts
Material	CZ	CZ - mild steel DC01
Sheet thickness	1.2	1.2 - sheet thickness 1.2 mm

20. MALE CONNECTOR ZM

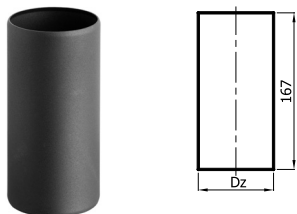

ZM x - CZ 1,2P

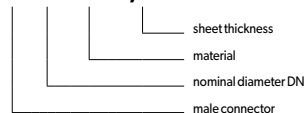

Caution!

Male connector allows to connect elements of the system with two bell-ended sides and divert the connection schema.

Diameter DN	ø80	ø100
Dz	80.1	100.2
Weight [kg]	0.45	0.55

Destination	D	D - smoke ducts
Material	CZ	CZ - mild steel DC01
Sheet thickness	1.2	1.2 - sheet thickness 1.2 mm

21. CAP DK

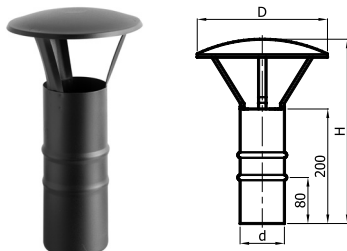

DK x - CZ 1,2P

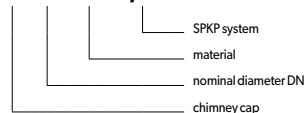

Diameter DN	ø80	ø100
d [mm]	77.2	96.9
D [mm]	160	220
H [mm]	285	220
Weight [kg]	0.31	1.44

Destination	D	D - smoke ducts
Material	X	X - stainless steel 1.4301 powder coated black colour
Sheet thickness	0.5	0.5 - sheet thickness 0.5 mm

22. TERMINAL WB

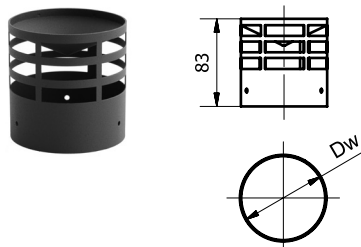

WB x - CZ 1,2P / TERMINAL

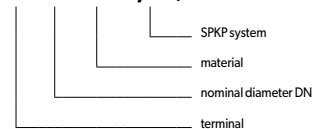

Diameter DN	ø80	ø100
Dw	82	102
Weight [kg]	0.15	0.20

Destination	D	D - smoke ducts
Material	X	X - stainless steel 1.4301 powder coated black colour
Sheet thickness	0.5	0.5 - sheet thickness 0.5 mm

23. TERMINAL WITH COVER

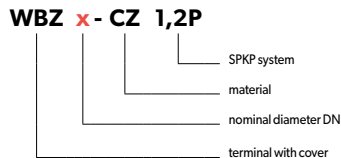
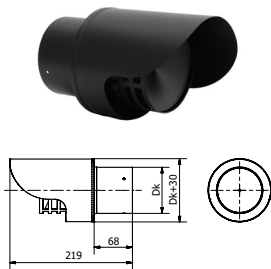

Diameter DN	ø80	ø100
Dk	81	101
Weight [kg]	0.4	0.45

Destination	D	D - smoke ducts
Material	X	X - stainless steel 1.4301 powder coated black colour
Sheet thickness	0.5	0.5 - sheet thickness 0.5 mm

24. WALL INSERT TO CERAMIC CHIMNEYS WKCP

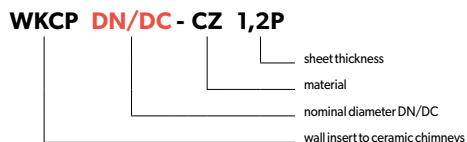
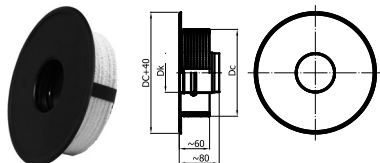

DC - chimney diameter
DN - chimney connection diameter

Diameter DN	ø80	ø100
Dk [mm]	81.1	101.2
Weight [kg]	0.71	0.77

Destination	D	D - smoke ducts
Material	CZ	CZ - mild steel DC01
Sheet thickness	1.2	1.2 - sheet thickness 1.2 mm

25. MOUNTING BRACKET OMD-I

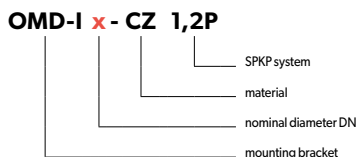
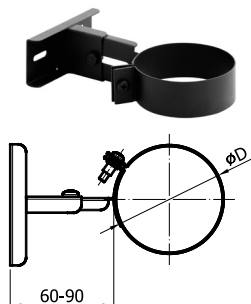

Diameter DN	ø80	ø100
øD [mm]	80	100
Weight [kg]	0.16	0.17

Destination	D	D - smoke ducts
Material	CZ	CZ - mild steel DC01

26. REVISION REPLACEMENT SEAL

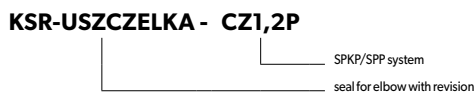

Caution! Sold in sets of 2 pcs.

27. SILICONE SEAL



28. MOUNTING SILICONE PASTE

